

## Two-stage product design selection by using PROMETHEE and Taguchi method: A case study

Crnjac, M.<sup>a,\*</sup>, Aljinovic, A.<sup>a</sup>, Gjeldum, N.<sup>a</sup>, Mladineo, M.<sup>a</sup>

<sup>a</sup>University of Split, Faculty of Electrical Engineering, Mechanical Engineering and Naval Architecture, Split, Croatia

### ABSTRACT

The main goal of this paper was to introduce the methodology for product design selection. The proposed methodology combines two classical methods to find the most appropriate design for the new product, through a reduced number of alternatives (product variants) and experiments for the selection process. In the first stage, the multi-criteria decision-making method, PROMETHEE was used for selecting the most suitable design, according to the chosen preferences and criteria. In the second stage, the Taguchi method was used in order to define the most appropriate parameters for selected suitable design. The fundamental scientific contribution of this paper refers to a benefit introduced by combining these methods. This benefit is related to the reduction of product development time which has a significant effect on manufacturing process time due to the high market pressure. The proposed methodology was applied to find the appropriate table design for CNC milling machine located in the Lean Learning factory. However, this is just one case study to present the proposed methodology which can be applied for other optimization of other product designs. Before applying the proposed methodology for this case study, the methodology is validated on a simple example.

© 2019 CPE, University of Maribor. All rights reserved.

### ARTICLE INFO

*Keywords:*

Learning factory;  
Lean manufacturing;  
Design optimization;  
PROMETHEE method;  
Taguchi method;

*\*Corresponding author:*

mcrnjac@fesb.hr  
(Crnjac, M.)

*Article history:*

Received 9 October 2018  
Revised 25 February 2019  
Accepted 27 February 2019

## 1. Introduction

Decision-making support in production is very important because it increases the competitiveness of companies. The digitalization introduction into the production system brings better support for decision-making. This is especially expressed during the development process of a new product. Embedded in 3D software, which is widely used for product design, there is also a very popular function of the Finite Element Method (FEM) simulation. During the development period of a new product, the methodology is very important because of the consequences that can affect cost and quality. Simulation helps to visualize how will the new product “behave” in its environment under the influence of different environmental factors. The step where it is necessary to choose the optimal design of that product represents the step of decision-making. This step means that the decision-maker identifies and selects an alternative from the set of alternatives (new product variants) based on its own preferences. Usually, there are several criteria to deal with, thus creating the multi-criteria problem and requiring multi-objective optimization.

However, product design is a very complex problem, since the criteria are very often mutually conflicting, resulting with engineering trade-off when some product properties are deliberately weakened in favour of some more important property. It means that the decision-makers preferences are known and that enables solving product design problems with some of the Multi-Criteria-Decision-Making (MCDM) methods. MCDM is a discipline that includes mathematics,

management, informatics, psychology, social science and economics. To solve the problem of choice and ranking, PROMETHEE method is often used [1]. MCDM methods are very popular in different areas, especially in operation research and logistics [2-4]. Avikal *et al.* [5] integrated Fuzzy Analytic Hierarchy Process (AHP) and PROMETHEE method in order to select tasks for assignment to the disassembly line. Fuzzy AHP was used to calculate the weights of each selected criterion while the PROMETHEE method was used for ranking the tasks. Peko *et al.* [6] showed the conduction of three different methods (AHP, Fuzzy AHP and PROMETHEE) to choose an appropriate additive manufacturing process. By comparing the results of each method, it is apparent that all methods gave the same rank of observed alternatives. Vinodh *et al.* [7] used PROMETHEE evaluation to select the best sustainable manufacturing concepts. There are three sustainability orientations according to production methodology, material and product design. They stated that the change of material is the best way to improve sustainability for the observed case. Can and Unuvar [8] present application of Taguchi method which enables reduction of experiments, when searching for the optimal parameters in the drilling process. On the other hand, Chang and Chen [9] integrated Taguchi method and TOPSIS algorithm to enhance the attractiveness of the product form.

Another example of using the Taguchi method in product design development is given by Oztekin *et al.* [10]. The method is used to determine the combination of product properties to find a design which takes consumer emotions into consideration. All of the above studies are dealing with MCDM methods to solve various problems and some of them used Taguchi method to reduce the number of experiments. This paper combines the strengths of both methods (PROMETHEE and Taguchi) to choose the optimal design.

The multi-objective optimization approach to product design selection is based on complex algorithms for shape optimization or its special case – the topology optimization. These algorithms are searching for the optimal design (shape) by considering, or not considering, some constraints. Usually, they are based on FEM and if the decision-maker preferences are unknown, it takes a dozens of days or weeks till the algorithm proposes the optimal shape or Pareto set of optimal shapes. In this research, that kind of approach is avoided, instead, it uses a different approach based on a priori knowledge [11] about product variants and decision-maker preferences.

The two-stage methodology is proposed for selecting the most appropriate design for the new product. In the first stage, the multi-criteria decision-making method PROMETHEE is used for selecting the most suitable design according to the chosen preferences and criteria. In the second stage, the Taguchi method is used in order to define the most appropriate parameters for selected suitable design (parameters like the diameter of the steel bar, the thickness of the steel tube, etc.). The methodology is developed so it could be applied in the Learning Factory environment, within the “Development of integrative procedure for management of production and service improvement process” (DEPROCIM) project funded by the Unity through Knowledge Fund (UKF).

The Lean Learning Factory (LLF) is the realistic factory environment created in the Laboratory for industrial engineering, at the University of Split, Faculty of Electrical Engineering, Mechanical Engineering and Naval Architecture (FESB). The LLF idea at FESB is to create an environment for research and development to provide knowledge transfer into the economy [12]. Learning factories should ensure appropriate and up-to-date knowledge about innovations [13]. It allows you to simulate various tasks that appear within a real-world manufacturing environment what helps students and industrial participants to gain knowledge faster [14]. The connection between digital models and methods, including simulation and 3D visualization, is done to integrate planning, implementation, control and on-going improvement [15].

This paper is organized as followed. In section 2, the observed problem is described. Section 3 shows steps of proposed methodology for product design selection. Section 4 explores the case study from the Lean Learning factory and emphasizes the advantage of using proposed methodology instead of classical methods. Section 5 sums up the contribution of this paper.

## 2. Problem description

Within the DEPROCIM project, the improvement of the case study on FESB, as one project goal, required further development of existing milling machine in order to support assembly line with the production of certain parts necessary for assembly. This paper presents modelling and simulation for choosing an optimal table design for the milling machine in the LLF environment, shown in Fig. 1. The compact design will increase the rigidity of the milling machine because the table legs will overtake feed forces necessary for the milling process. Other improvements on this milling machine include steel T-slot plate and improved linear guides.

Three different designs of tables had been taken into consideration. 3D models of each table design are shown in Fig. 2. For all table designs, the material is construction steel (St 44-2). The legs, frame, stiffener and table base are made of tubes with the quadratic cross-section, with thickness 3 mm. The table width, length and height are predefined. There is also the steel T-slot plate which is predefined.

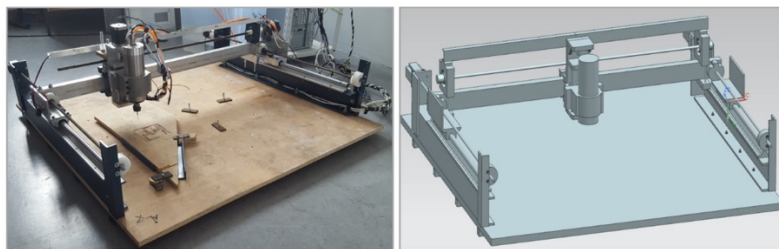

Fig. 1 Milling machine in LLF environment (real image and 3D)

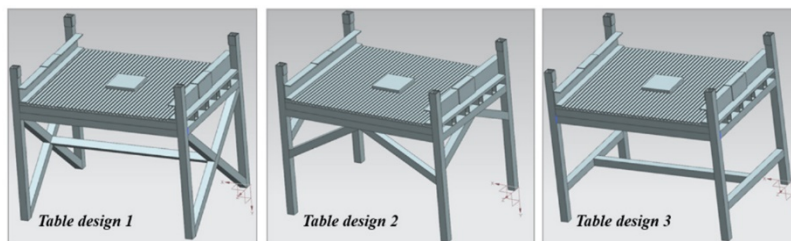

Fig. 2 3D models of Table design 1, 2 and 3

## 3. Proposed method for product design selection

This study uses the combination of two classic methods for product design selection, PROMETHEE (Preference Ranking Organization Method for Enrichment Evaluations) method and Taguchi method. The PROMETHEE method was used for selecting the most suitable design between proposed ones. The selected design was further used in Taguchi method for evaluation of the most appropriate combination of parameters. In order to gain all the necessary data for the mentioned methods, the first step was the creation of 3D models and their simulation by using the FEM analysis. The idea of FEM is a piecewise approximation. The solution to a complicated problem is obtained by dividing the region of interest into small regions (finite elements) and approximating the solution over each sub-region by a simple function [16]. This method has become popular and it represents a powerful analytical tool for studying different engineering problems [17, 18]. The PROMETHEE method combined with Taguchi method is carried out according to the input criteria provided by decision-maker and simulation results, Fig 3.

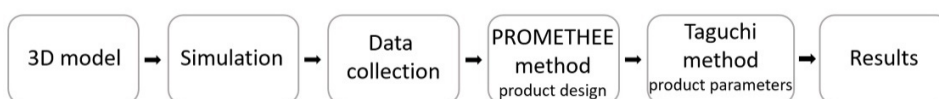

Fig. 3 Methodology for decision making for product design

### 3.1 PROMETHEE method

The PROMETHEE method is widely used because it has the adaptability to different problems and its implementation is simple [19-21]. This method was developed by J. P. Brans. Input information for the PROMETHEE method is a definition of several important criteria and decision-makers' preferences. It represents the definition of the function of decision-makers' preferences [22]. The function of preferences provides quantitative determination of how decision-maker prefers an alternative  $a$  in relation to alternative  $b$ . The function of preferences is defined for each criterion and its values may be in the range between 0 and 1. If the function of preferences is low, it means that the indifference between two alternatives is bigger for the decision-maker. If the value of the function of preferences is close to 1, then the preference of one alternative is bigger than the other. Complete preference of one alternative means that the function of preferences is 1. The function  $f(a)$  represents the assessment of alternative  $a$  for specific criteria and alternative  $a$  belongs to the set  $A$ . If the two alternatives,  $a$  and  $b$ , are taken from the set  $A$ , the relation of preference of the alternative  $a$  according to the alternative  $b$  is defined by function  $P(a,b)$ . In this example the function  $P(a,b)$  is  $P(d)$  where  $d$  represents:

$$d = f(a) - f(b) \quad (1)$$

The function of preferences has six different types. Those types cover most cases in practice and decision-maker should define parameters according to the chosen criteria [23].

### 3.2 Taguchi method

The founder of the Taguchi method is Genichi Taguchi. His robust design method was applied in the quality field but it can be applied to different problems in many industries. It is also the support for decision making. There are three important design stages in the Taguchi method [24]. System design, which is characterized by definition of the problem and application of knowledge and achievements to develop a prototype that represents the initial state of the product or process features. Parameter design determines the initial states of all features, which will minimize product or process variations. In recent years, Taguchi method has become a powerful tool for improving products and processes [25]. The orthogonal field is selected depending on the number of controlled parameters. The experiments are performed based on the orthogonal field, the data are analysed and the optimal state is identified. Tolerance design determines the tolerance of features, which will minimize product or process variations. P-diagram used as the base model for the Taguchi method is shown in Fig. 4.

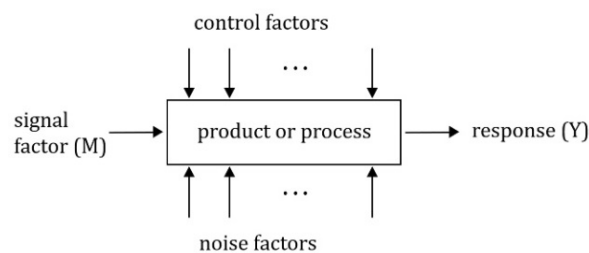

Fig. 4 P-diagram [24]

There is the signal factor and the response, but there are also control and noise factors that affect the process or the product. The main goal of the Taguchi method is to reduce losses of product or process due to deviations from its properties of the desired value. Taguchi defines quality loss as:

$$L(y) = k(y - m)^2 \quad (2)$$

Where  $y$  is the quality characteristic of a product,  $m$  is the target value for  $y$ . The  $k$  is constant and represents the coefficient of quality loss. There are four variations of the quadratic loss function: nominal the best, smaller the better, larger the better and asymmetric. This paper uses the smaller the better variation of the loss function.

## 4. Case study: Results and discussion

To demonstrate the advantages of the proposed methodology that will be used for concrete problem, table design for CNC milling machine, its application on less complex design was introduced in the beginning of this section. Besides the structure complexity, less complex design means a smaller number of overall possible alternatives and thereby, a smaller number of total experiments that need to carry out. In the PROMETHEE method, for the simple example, all alternatives were included in the selection of the design for Taguchi, to show the comparison of the final result obtained with the classic method and proposed methodology.

### 4.1 Simple example – PROMETHEE method

The basic principles to implement the PROMETHEE method is a pairwise comparison of alternatives evaluated according to determined criteria which have to be maximized or minimized. According to the literature, there are many different criteria for selection. The choice depends on the concrete problem. The aim of this following example is to show the choice of criteria and selection of appropriate design, Fig. 5. For each product design, three criteria (legs, frame and stiffener) were selected. Each of these criteria has two levels: the first level of legs is 40 mm and second 50 mm, criteria frame has 40 mm and 50 mm; criteria stiffener 20 mm and 30 mm respectively. These designs were loaded with force to demonstrate displacements through X, Y and Z-axis. The legs, frame and stiffener are made of tubes with the quadratic cross-section, with 2 mm thickness. The width, height and material of construction are predefined.

Through these combinations of levels, 8 alternatives were generated for each product design. That represents all possible alternatives of variants A and B. The preference functions for each of these criteria are determined according to Fig. 6. For each criterion, despite the determination min or max of function preferences, it was necessary to define the relative importance (the weights). These values of the weight coefficient are present in percentage with the total amount of 100 %. For criteria that have determined linear as preference function, the value of indifference threshold  $q$  and the value of strict preference threshold  $p$  are also defined. For each alternative, required data were entered and thus an input matrix was formed, Fig. 6.

Positive outranking flow,  $\Phi_i^+$ , is an aggregated outranking sum of each alternative over the other alternatives, while negative outranking flow,  $\Phi_i^-$ , shows how alternative is dominated by the other alternatives [26]. According to the usage of mentioned outranking flows, it is possible to define two approaches for alternative ranking, PROMETHEE I and PROMETHEE II. PROMETHEE I represents the partial ranking of alternatives and PROMETHEE II represents the full ranking of alternatives.

For this example, the PROMETHEE method was conducted two times. The first approach includes all possible alternatives of design A and design B. It gives their overall ranking, as is shown in Table 1. The best rank belongs to B4 alternative.

The second approach presents the first step of the proposed methodology. Instead of ranking all potential combinations (16 in this case), a selection between two potential designs was made. The analysis shows that B variant should be observed for further optimization, Fig. 7.

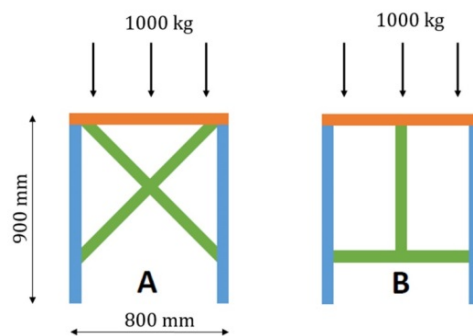

Fig. 5 Variants of product design

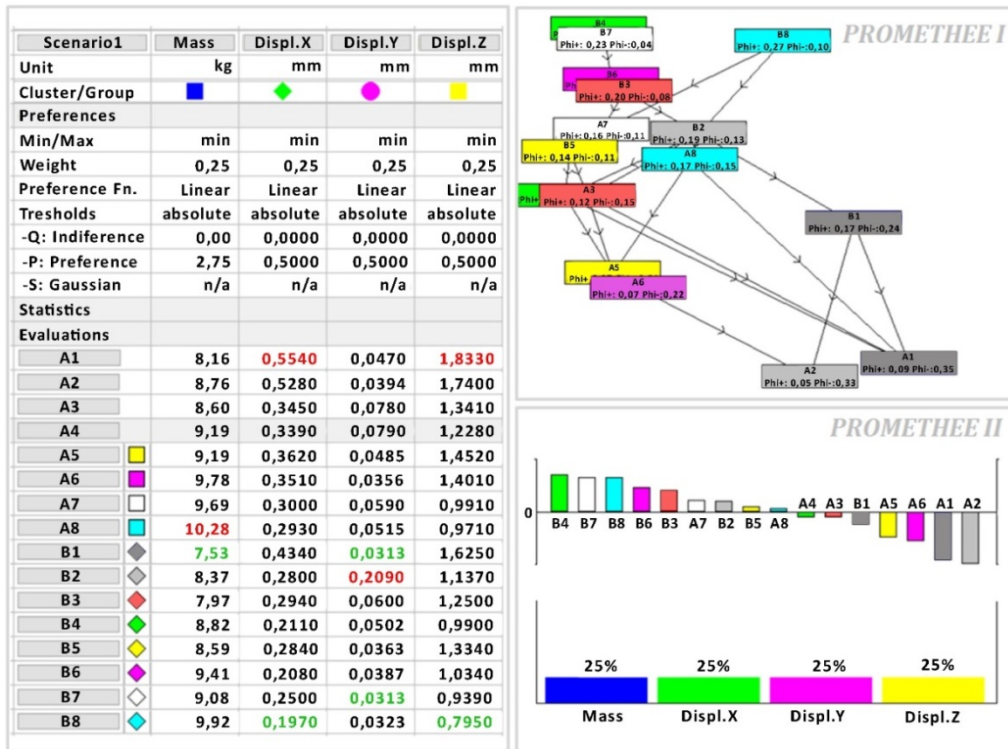

Fig. 6 Input matrix and results according to PROMETHEE I and PROMETHEE II (for all variants)

Table 1 All alternatives of product variants

Alternative	Legs [mm]	Frame [mm]	Stiffener [mm]	Displ. X [mm]	Displ. Y [mm]	Displ. Z [mm]	Mass [kg]	PROMETHEE rank
A1	40	40	20	0.5540	0.0470	1.8330	8.16	15
A2	40	40	30	0.5280	0.0394	1.7400	8.76	16
A3	40	50	20	0.3450	0.0780	1.3410	8.60	11
A4	40	50	30	0.3390	0.0790	1.2280	9.19	10
A5	50	40	20	0.3620	0.0485	1.4520	9.19	13
A6	50	40	30	0.3510	0.0356	1.4010	9.78	14
A7	50	50	20	0.3000	0.0590	0.9910	9.69	6
A8	50	50	30	0.2930	0.0515	0.9710	10.28	9
B1	40	40	20	0.4340	0.0313	1.6250	7.53	12
B2	40	40	30	0.2800	0.2090	1.3700	8.37	7
B3	40	50	20	0.2940	0.0600	1.2500	7.97	5
B4	40	50	30	0.2110	0.0502	0.9900	8.82	1
B5	50	40	20	0.2840	0.0363	1.3340	8.59	8
B6	50	40	30	0.2080	0.0387	1.0340	9.41	4
B7	50	50	20	0.2500	0.0313	0.9390	9.08	2
B8	50	50	30	0.1970	0.0323	0.7950	9.92	3

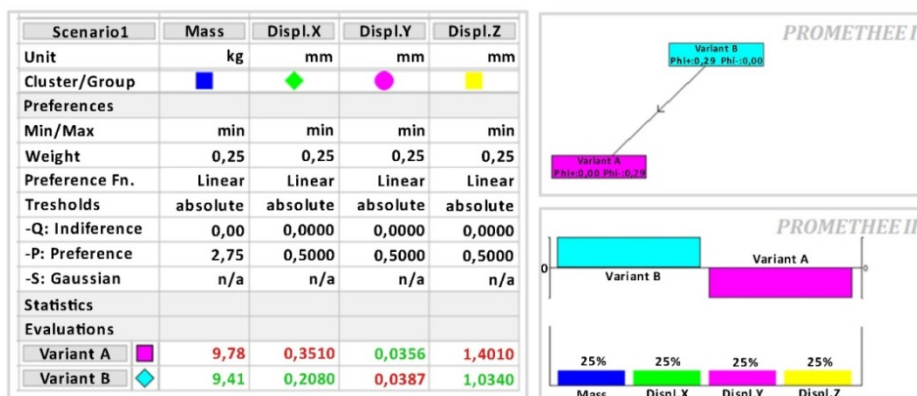

Fig. 7 Input matrix and results according to PROMETHEE I and PROMETHEE II (for two designs)



#### 4.2 Simple example – Taguchi method

In order to create the plan of experiments, it was necessary to define parameters and their levels as it is mentioned before. To reduce the number of experiments, the orthogonal arrays are used in the Taguchi method. It represents the partial plan of experiments. The orthogonal arrays enable the observation of the effect on an individual parameter regardless of the evaluation of the effects of other system parameters. Definition of key parameters and their levels determines an appropriate orthogonal array. For this example, the L4 is chosen as an orthogonal array because there are three key parameters on two different levels which are shown in Fig. 1. Orthogonal array L4 covers 4 experiments, according to the literature [24]. Parameters and their levels were entered in Design Expert 11.0, where Taguchi method is used to find the best combination of parameters according to chosen levels. Data about the given combination for B variant are shown in Table 2.

To conduct the Taguchi method for this example, due to dispersion of response data, it was necessary to include two more experiments to gain a significant model that can be used to navigate the design space. The value of signal to noise ratio for this model is 16.43 and that indicates an adequate signal. The analysis of variance for response displacement Z is shown in Table 3,  $F$ -value is 36.17 which implies that the model is significant. There is only 2.70 % chance that  $F$ -value could appear due to noise.  $p$ -values less than 0.05 indicate that the model factors (A, B, C) are significant.

The main aim during the analysis of responses was the minimization of displacements and mass. For the purposes of analysis, it was necessary to define the importance for each response. According to the conducted FEM analysis, the chosen vertical loads have the greatest influence on the movements in the direction of the Z-axis, hence response displacement Z has the highest importance. The selected combination of parameters for this example is shown in Table 4.

The Taguchi optimum obtained with the proposed methodology is B design with dimensions of 40x50x30 mm. By comparing this final solution with the PROMETHEE solutions in Table 1, in which rang 1 means real optimum design (B4 design), i.e. the most suitable choice, it is obvious that these two methods show the same final solution.

**Table 2** The plan of experiments for B variant

Run	Legs [mm]	Frame [mm]	Stiffener [mm]	Displ. X [mm]	Displ. Y [mm]	Displ. Z [mm]	Mass [kg]
1	40	40	20	0.4340	0.0313	1.6250	7,53
2	50	50	20	0.2500	0.0313	0.9390	9,08
3	40	50	30	0.2110	0.0502	0.9900	8,82
4	50	40	30	0.2080	0.0387	1.0340	9,41
5	50	40	20	0.2810	0.0364	1.3320	8,59
6	50	50	30	0.1970	0.0323	0.7950	9,92

**Table 3** ANOVA for selected factorial model, response: displacement Z

Source	Sum of squares	df	Mean square	$F$ -value	$p$ -value	
Model	0.4551	3	0.1517	36.17	0.0270	significant
A-legs	0.1060	1	0.1060	25.28	0.0374	
B-frame	0.1550	1	0.1550	36.97	0.0260	
C-stiffener	0.0807	1	0.0807	19.24	0.0482	
Residual	0.0084	2	0.0042			
Cor Total	0.4635	5				

**Table 4** Selected solution

No.	Legs [mm]	Frame [mm]	Stiffener [mm]	Displ. X [mm]	Displ. Y [mm]	Displ. Z [mm]	Mass [kg]	Desirability
1	40	50	30	0.245	0.050	1.014	8.83	0.242 selected

**4.3 Table example – Criteria formation and analysis of the results obtained by PROMETHEE method**

According to the presented problem in section 2, the input data necessary to select the best alternative for table design using the PROMETHEE method is defined, as is shown in Fig. 8. For this purpose, five criteria for three variants are observed. As the cost of the table is the most important factor which should fit in the limited budget, the development of three variants of the tables is done in order to get different table shapes for the approximately same cost. Considering that the cost for each table design does not deviate significantly, it is not taken as criteria for the PROMETHEE method. The preference functions for each of the criteria are determined according to [23, 27]. For criteria mass and displacements, the preference function is linear. Linear functions are the best for quantitative criteria (for example: prices, costs, power, etc.). In the case of the small number of levels, on the criterion scale (that is 5-point scale) for qualitative criteria, the usual preference function is recommended and therefore used [22].

For this scenario, criteria are defined according to subjective opinion. In the preference category, it is necessary to define max or min preferences for each criterion, which is the maximum for construction criterion and minimum for the rest. The construction criterion for this case is based on qualitative assessment of the construction strength, with regard to its shape and assembly. In this case, the assembly is not included as individual criterion because this product will be assembled in LLF. Generally, when using this method, the complexity of assembly could be included as a criterion. Through this criterion, it is possible to have an effect on the assembly process, which will reflect on whole manufacturing process efficiency. However, the contribution of this criterion on the assembly process will be affected by the definition of criteria weights, preference functions and its values.

The most suitable solution is the one that acquires the overall preference as close as possible to the value +1 (greatest possible preferences). PROMETHEE I shows the ranking of alternatives at the left side of Fig. 9. The alternative with the highest priority is table design 1 and it has domination above other designs. Table design 2 and 3 are incomparable with each other because table design 2 has the better score on *Phi+* and worse score on *Phi-* and vice versa for table design 3. At the right side of Fig. 9, there is a complete ranking with PROMETHEE II, which confirms our previous statements. The results of partial and complete ranking demonstrate that the table design 1 is the most favourable, with the preferences of +0.1801, hence this alternative is used for further optimization with Taguchi method.

Scenario1	Construction	Mass	Displ.X	Displ.Y	Displ.Z	
Unit	5-point	kg	mm	mm	mm	
Cluster/Group						
Preferences						
Min/Max	max	min	min	min	min	
Weight	0,20	0,20	0,20	0,20	0,20	
Preference Fn.	Usual	Linear	Linear	Linear	Linear	
Thresholds	absolute	absolute	absolute	absolute	absolute	
-Q: Indifference	n/a	5,00	0,0000	0,0000	0,0000	
-P: Preference	n/a	25,00	0,5000	0,5000	0,5000	
-S: Gaussian	n/a	n/a	n/a	n/a	n/a	
Statistics						
Minimum	4,00	234,00	0,0062	0,0186	0,0035	
Maximum	5,00	244,00	0,0077	0,0215	0,0180	
Average	4,33	239,00	0,0070	0,0201	0,0113	
Standard Dev.	0,47	4,08	0,0006	0,0012	0,0060	
Evaluations						
TableDesign1		very good	244,00	0,0062	0,0201	0,0035
TableDesign2		good	239,00	0,0072	0,0186	0,0123
TableDesign3		good	234,00	0,0077	0,0215	0,0180

Fig. 8 Input matrix for PROMETHEE method



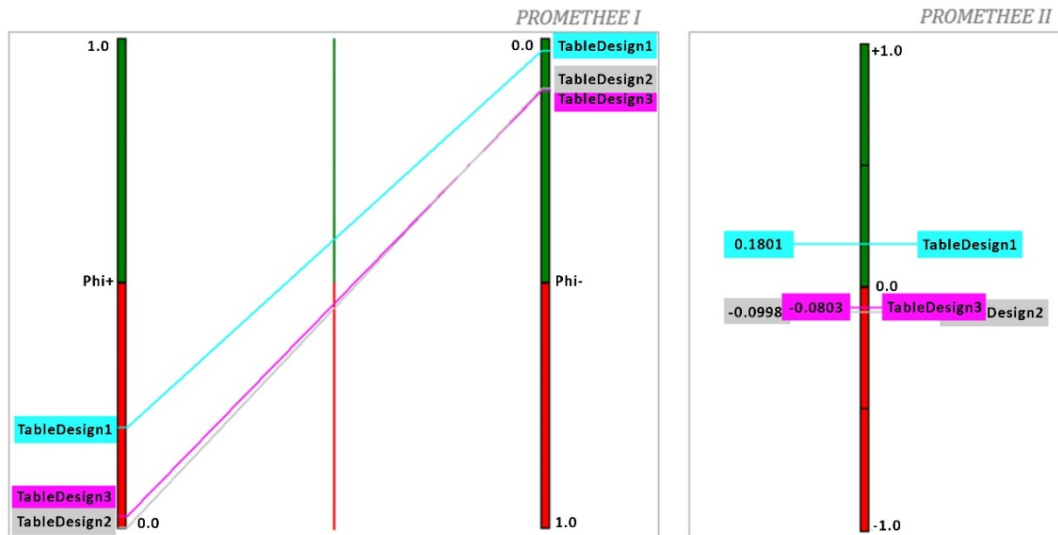

Fig. 9 Partial ranking with PROMETHEE I and complete ranking with PROMETHEE II for the best table design

**4.4 Table example – Criteria formation and analysis of the results obtained by Taguchi method**

Table design 1 has domination above other designs and its key parameters were defined. The data about experiments are shown in Table 5. For each variant of table design 1, generated by software Design Expert, from 1 to 9, displacement and mass were calculated by using NX Siemens 10.0 software.

To calculate displacement, it was necessary to define loads for table design 1. The loads are shown in Fig. 10 and the fixed constraint is set on the surface of legs that lay on the floor.

**Table 5** The plan of experiments from Design Expert 11.0 software

Run	Factor 1: Legs & frame [mm]	Factor 2: Stiffener [mm]	Factor 3: Table base [mm]	Response 1: Displ. X [mm]	Response 2: Displ. Y [mm]	Response 3: Displ. Z [mm]	Response 4: Mass [kg]
1	50	40	50	6.60E-03	2.10E-02	3.93E-03	239.67
2	70	40	40	6.10E-03	2.33E-02	3.56E-03	252.27
3	60	40	60	4.80E-03	1.44E-02	2.99E-03	255.96
4	50	50	60	5.40E-03	1.60E-02	2.83E-03	251.12
5	60	30	50	5.80E-03	1.87E-02	3.74E-03	244.72
6	70	50	50	5.10E-03	1.73E-02	2.55E-03	263.38
7	70	30	60	4.50E-03	1.37E-02	2.72E-03	260.95
8	60	50	40	6.60E-03	2.40E-02	4.23E-03	247.39
9	50	30	40	8.20E-03	2.85E-02	5.52E-03	228.42

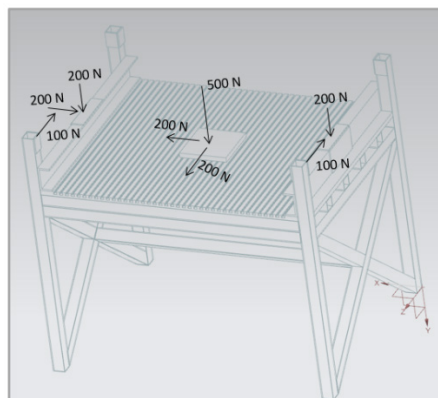

Fig. 10 The load distribution for table design 1

The results of the experiments are analysed and significant parameters are detected. The analysis of variance (ANOVA) verifies the influence on system response when parameters are changing [28]. The ANOVA shows  $F$ -value 76.88 which means that the model is significant. It is 1.29 % chance that  $F$ -value could appear because of noise.  $p$ -values that are less than 0.05 indicate model terms are significant. In this case, legs & frame and table base are significant in model terms. Stiffener has  $p$ -value that is higher than 0.1, that means that it is not significant in model terms.  $S-N$  ratio measures the signal to noise ratio which is 24.98. When this ratio is greater than 4, it indicates an adequate signal as it was mentioned in a simple example. The main effect plots are shown in Fig. 11 for displacement Y. It is visible that stiffener is not significant for the model.

The ANOVA for response mass shows  $F$ -value 14519.51 which means that the model is significant. It is 0.01 % chance that  $F$ -value could appear because of noise. In this case, legs & frame, stiffener and table base are significant in model terms.  $S-N$  ratio is 380.858 and it is desirable. It indicates an adequate signal. Displacement and mass were chosen as responses that should be minimum. The importance is higher for the displacement than for the mass. For displacement Y lower limit is 0.0137 mm and the upper limit is 0.0285 mm. For mass, the lower limit is 228.42 kg and the upper limit is 263.38 kg. The optimal solution is found and parameters for table design 1 are: legs & frame 60 mm, stiffener 40 mm, table base 60 mm. For this combination of parameters, displacements and mass are shown in Table 6. The Taguchi method has found 24 solutions. As the optimal solution it gives the combination of parameters under the run 3, which is part of the previous plan of experiments, shown in Table 5.

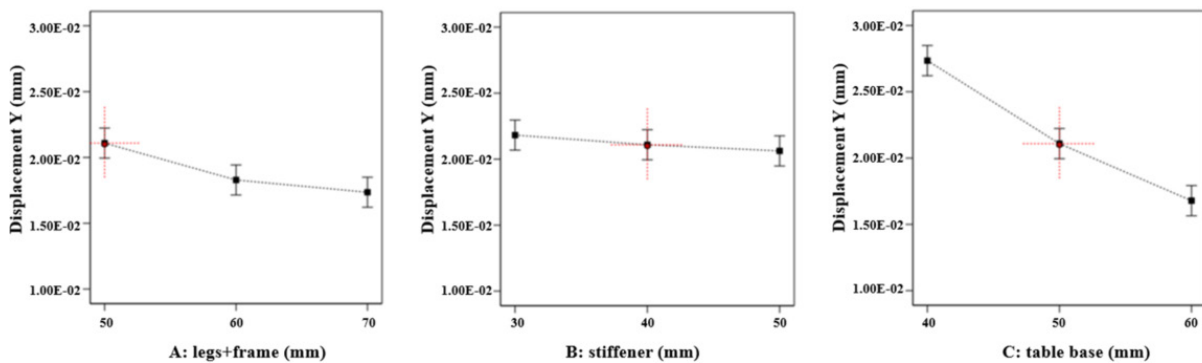

Fig. 11 Main effects for response displacement Y, change of each factor depending on level

Table 6 Solution for the best parameters of table design 1

No.	Legs & Frame [mm]	Stiffener [mm]	Table base [mm]	Displ. X [mm]	Displ. Y [mm]	Displ. Z [mm]	Mass [kg]	Desirability	
1	60	40	60	0.005	0.014	0.003	256	0.579	selected

#### 4.5 Two stage selection of product design using PROMETHEE and Taguchi method: Discussion

The main aim of this paper was to show an advantage of the proposed methodology with an emphasis on the number of experiments that have to be done. Table 7 shows the comparison of differences between classical methods and proposed methodology in terms of the number of variants on the simple example presented in section 4 and the design of table for CNC milling machine. The simple example consists of 2 designs with 3 factors on 2 levels, which means that for the PROMETHEE method it is necessary to prepare 16 variants. If the design of table for CNC milling machine is chosen using the mentioned method, it will be necessary to prepare 81 variants. The simple example was conducted to verify the final result of the proposed methodology with the result obtained by the classical method. It can be seen that the real optimum result from PROMETHEE method coincides with Taguchi optimum gained by the proposed methodology.

**Table 7** Comparison of different approaches and number of necessary variants to include in the selection

Approach	Simple example (section 4)	Design for CNC milling machine	Optimum
	2 designs, 3 factors, 2 levels	3 designs, 3 factors, 3 levels	
Classical selection of the best variant – PROMETHEE method	$2 \times 2^3 =$ 16 variants	$3 \times 3^3 =$ 81 variants	real optimum
Classical selection of the best variant – Taguchi method	$2 \times 4 =$ 8 variants	$3 \times 9 =$ 27 variants	Taguchi optimum
Two-stage product design selection using PROMETHEE and Taguchi method	$(2 - 1) + 4 =$ 5 variants (+2)*	$(3 - 1) + 9 =$ 11 variants	Taguchi optimum

\* For this example it was necessary to include two more experiments to gain a significant model; detailed explanation is in subsection 4.2

## 5. Conclusion

The research on how to combine different methods and find an optimal solution is presented in this paper. Today, time is the crucial factor in the design product stage and decision-making support is an important part in manufacturing or research and development process. The longer period of the design phase has effects on the production of a product. This situation is characteristic when it is not clear what properties product should exactly satisfy. Proposed methodology shows the reduction of variants and number of its experiments with help of criteria that should be defined in the beginning in order to reduce search space. It is visible that the number of experiments increases significantly when there is just a small increase in the number of designs, in fact, search space becomes larger. The advantages of the proposed methodology are identified through the comparison of different approaches. Time is saved for the search of appropriate variants and optimum is reached as in the case of the “whole space search”. The PROMETHEE method helps to find the best solution according to the decision-makers’ selection. Combining it with the Taguchi method, the number of experiments is reduced and it is easy to find out which parameter is significant and how each parameter affects the whole system (product or process). Usage of the strengths of both methods resulted in the two-stage methodology. This new combination of methods mostly contributes in the product design phase while searching for the most appropriate solution according to the “a priori” defined alternatives and criteria.

## Acknowledgement

This work has been fully supported by the Unity Through Knowledge Fund (UKF), 1C My First Collaboration Grant, under the project 11/17 Development of integrative procedure for management of production and service improvement process.

## References

- [1] Ishizaka, A., Nemery, P. (2013). *Multi-criteria decision analysis: Methods and software*, John Wiley & Sons, New Delhi, India, doi: [10.1002/9781118644898](https://doi.org/10.1002/9781118644898).
- [2] Govindan, K., Rajendran, S., Sarkis, J., Murugesan, P. (2015). Multi criteria decision making approaches for green supplier evaluation and selection: A literature review, *Journal of Cleaner Production*, Vol. 98, 66-83, doi: [10.1016/j.jclepro.2013.06.046](https://doi.org/10.1016/j.jclepro.2013.06.046).
- [3] Mladineo, M., Veza, I., Gjeldum, N. (2017). Solving partner selection problem in cyber-physical production networks using the HUMANT algorithm, *International Journal of Production Research*, Vol. 55, No. 9, 2506-2521, doi: [10.1080/00207543.2016.1234084](https://doi.org/10.1080/00207543.2016.1234084).
- [4] Mardani, A., Jusoh, A., Zavadskas, E.K. (2015). Fuzzy multiple criteria decision-making techniques and applications – Two decades review from 1994 to 2014, *Expert Systems with Applications*, Vol. 42, No. 8, 4126-4148, doi: [10.1016/j.eswa.2015.01.003](https://doi.org/10.1016/j.eswa.2015.01.003).
- [5] Avikal, S., Mishra, P.K., Jain, R. (2014). A Fuzzy AHP and PROMETHEE method-based heuristic for disassembly line balancing problems, *International Journal of Production Research*, Vol. 52, No. 5, 1306-1317, doi: [10.1080/00207543.2013.831999](https://doi.org/10.1080/00207543.2013.831999).
- [6] Peko, I., Gjeldum, N., Bilić, B. (2018). Application of AHP, fuzzy AHP and PROMETHEE method in solving additive manufacturing process selection problem, *Tehnički Vjesnik – Technical Gazette*, Vol. 25, No. 2, 453-461, doi: [10.17559/TV-20170124092906](https://doi.org/10.17559/TV-20170124092906).

- [7] Vinodh, S., Girubha, R.J. (2012). PROMETHEE based sustainable concept selection, *Applied Mathematical Modelling*, Vol. 36, No. 11, 5301-5308, doi: [10.1016/j.apm.2011.12.030](https://doi.org/10.1016/j.apm.2011.12.030).
- [8] Can, A., Ünüvar, A. (2017). Optimization of process parameters in drilling of SMC composites using Taguchi method, *Tehnički vjesnik – Technical Gazette*, Vol. 24, No. 2, 435-442, doi: [10.17559/TV-20160103215256](https://doi.org/10.17559/TV-20160103215256).
- [9] Chang, H.-C., Chen, H.-Y. (2014). Optimizing product form attractiveness using Taguchi method and TOPSIS algorithm: A case study involving a passenger car, *Concurrent Engineering*, Vol. 22, No. 2, 135-147, doi: [10.1177/1063293X13520317](https://doi.org/10.1177/1063293X13520317).
- [10] Oztekin, A., Iseri, A., Zaim, S., Nikov, A. (2013). A Taguchi-based Kansei engineering study of mobile phones at product design stage, *Production Planning & Control*, Vol. 24, No. 6, 465-474, doi: [10.1080/09537287.2011.633575](https://doi.org/10.1080/09537287.2011.633575).
- [11] Mladineo, M., Celar, S., Celent, L., Crnjac, M. (2018). Selecting manufacturing partners in push and pull-type smart collaborative networks, *Advanced Engineering Informatics*, Vol. 38, 291-305, doi: [10.1016/j.aei.2018.08.001](https://doi.org/10.1016/j.aei.2018.08.001).
- [12] Gjeldum, N., Mladineo, M., Veza, I. (2016). Transfer of model of innovative smart factory to Croatian economy using lean learning factory, *Procedia CIRP*, Vol. 54, 158-163, doi: [10.1016/j.procir.2016.06.096](https://doi.org/10.1016/j.procir.2016.06.096).
- [13] Abele, E., Metternich, J., Tisch, M., Chryssolouris, G., Sihn, W., ElMaraghy, H., Hummel, V., Ranz, F. (2015). Learning factories for research, education, and training, *Procedia CIRP*, Vol. 32, 1-6, doi: [10.1016/j.procir.2015.02.187](https://doi.org/10.1016/j.procir.2015.02.187).
- [14] Prinz, C., Morlock, F., Freith, S., Kreggenfeld, N., Kreimeier, D., Kuhlenkötter, B. (2016). Learning factory modules for smart factories in Industrie 4.0, *Procedia CIRP*, Vol. 54, 113-118, doi: [10.1016/j.procir.2016.05.105](https://doi.org/10.1016/j.procir.2016.05.105).
- [15] Herrmann, C., Schmidt, C., Kurle, D., Blume, S., Thiede, S. (2014). Sustainability in manufacturing and factories of the future, *International Journal of Precision Engineering and Manufacturing-Green Technology*, Vol. 1, No. 4, 283-292, doi: [10.1007/s40684-014-0034-z](https://doi.org/10.1007/s40684-014-0034-z).
- [16] Rao, S.S. (2017). *The finite element method in engineering*, (6th edition), Butterworth-Heinemann, Oxford, UK, doi: [10.1016/C2016-0-01493-6](https://doi.org/10.1016/C2016-0-01493-6).
- [17] Özkal, F.M., Cakir, F., Arkun, A.K. (2016). Finite element method for optimum design selection of carport structures under multiple load cases, *Advances in Production Engineering & Management*, Vol. 11, No. 4, 287-298, doi: [10.14743/apem2016.4.227](https://doi.org/10.14743/apem2016.4.227).
- [18] Wang, Y., Lu, Y.J., Si, C.D., Sun, T.C. (2017). Finite element analysis for rutting prediction of asphalt concrete pavement under moving wheel load, *International Journal of Simulation Modelling*, Vol. 16, No. 2, 229-240, doi: [10.2507/IJSIMM16\(2\)4.374](https://doi.org/10.2507/IJSIMM16(2)4.374).
- [19] Sari, T., Timor, M. (2016). Integrated supplier selection model using ANP, Taguchi loss function and PROMETHEE methods, *Journal of Applied Quantitative Methods*, Vol. 11, No. 1, 19-34.
- [20] Brans, J.-P., De Smet, Y. (2016). PROMETHEE methods, In: Greco, S., Ehrgott, M., Rui Figueira, J. (eds.), *Multiple Criteria Decision Analysis*, Springer, New York, USA, 187-219, doi: [10.1007/978-1-4939-3094-4](https://doi.org/10.1007/978-1-4939-3094-4).
- [21] Behzadian, M., Kazemzadeh, R.B., Albadvi, A., Aghdasi, M. (2010). PROMETHEE: A comprehensive literature review on methodologies and applications, *European Journal of Operational Research*, Vol. 200, No. 1, 198-215, doi: [10.1016/j.ejor.2009.01.021](https://doi.org/10.1016/j.ejor.2009.01.021).
- [22] Brans, J.-P., Mareschal, B. (2005). PROMETHEE methods, In: Figueira, J., Greco, S., Ehrgott, M. (eds.), *Multiple Criteria Decision Analysis: State of the Art Surveys*, Vol. 78, Springer, New York, USA, 163-186, doi: [10.1007/0-387-23081-5\\_5](https://doi.org/10.1007/0-387-23081-5_5).
- [23] Brans, J.P., Vincke, Ph. (1985). Note – A preference ranking organization method (The PROMETHEE method for Multiple Criteria Decision-Making), *Management Science*, Vol. 31, No. 6, 647-784, doi: [10.1287/mnsc.31.6.647](https://doi.org/10.1287/mnsc.31.6.647).
- [24] Phadke, M.S. (1995). *Quality engineering using robust design*, Prentice Hall PTR, New Jersey, USA.
- [25] Li, Y., Zhu, L. (2017). Optimisation of product form design using fuzzy integral-based Taguchi method, *Journal of Engineering Design*, Vol. 28, No. 7-9, 480-504, doi: [10.1080/09544828.2017.1346239](https://doi.org/10.1080/09544828.2017.1346239).
- [26] Genç, T., Dinçer, S.E. (2013). Visual analysis for multi criteria decision problems by PROMETHEE method and gaia plane: An application, determine the level of regional socio-economic development in Turkey, *Trakya University Journal of Social Science*, Vol. 15, No. 2, 111-130.
- [27] Mareschal, B. The PROMETHEE – GAIA FAQ, from <http://www.promethee-gaia.net/>, accessed July 11, 2018.
- [28] Cardinal, R.N., Aitken, M.R.F. (2013). *ANOVA for the behavioral sciences researcher*, Psychology Press, New York, USA, doi: [10.4324/9780203763933](https://doi.org/10.4324/9780203763933).